



**Augenti**<sup>®</sup>  
LIGHTING

# NEON STRIP







ALL YOU  
NEED IS  
LESS

**NEON STRIP** collection

# NEON STRIP collection

Nella luminosa essenza del “All you need is less”, scopriamo che la bellezza autentica risiede nell'elegante semplicità. Adatte a spazi interni ed esterni, queste strisce luminose incarnano l'innovazione, conferendo agli ambienti una luminosità avvolgente.

La struttura in gomma offre una **flessibilità** senza pari, permettendo alle **Neon Strip** di adattarsi con grazia ad ogni spazio senza comprometterne il design e l'estetica. L'elegante minimalismo di questo prodotto ne permette un'armoniosa integrazione nei più disparati contesti architettonici: sia che si tratti di accentuare linee architettoniche, creare giochi di luce o delineare con precisione aree specifiche, le nostre Neon Strip di gomma sono la soluzione illuminotecnica che donerà ai vostri spazi un tocco contemporaneo e raffinato.

Coniugando **funzionalità** e **design**, il potenziale creativo di queste strip offre un'esperienza di illuminazione su misura per ogni esigenza.

In the bright essence of “All you need is less”, we discover that authentic beauty lies in elegant simplicity. Suitable for indoor and outdoor spaces: these light strips embody innovation, giving the rooms an enveloping brightness.

The rubber structure offers unparalleled **flexibility**, allowing the **Neon Strip** to gracefully adapt to any space without compromising design and aesthetics. The elegant minimalism of this product allows a harmonious integration in the most disparate architectural contexts: whether it is to accentuate architectural lines, create plays of light or precisely delineate specific areas, our rubber Neon Strip are the lighting solution that will give your spaces a contemporary and refined touch. Combining **functionality** and **design**, the creative potential of these strips offers a lighting experience tailored to every need.

Dans l'essence lumineuse du “All you need is less”, nous découvrons que la beauté authentique réside dans l'élégante simplicité. Adaptées aux espaces intérieurs et extérieurs, ces bandes lumineuses incarnent l'innovation, en donnant aux pièces une luminosité enveloppante.

La structure en caoutchouc offre une **flexibilité** inégalée, permettant aux **Neon Strip** de s'adapter avec grâce à chaque espace sans compromettre le design et l'esthétique. L'élégant minimalisme de ce produit permet une intégration harmonieuse dans les contextes architecturaux les plus disparates: qu'il s'agisse d'accentuer des lignes architecturales, de créer des jeux de lumière ou de délimiter avec précision des zones spécifiques, nos Neon Strip en caoutchouc sont la solution d'éclairage qui donnera à vos espaces une touche contemporaine et raffinée.

Alliant **fonctionnalité** et **design**, le potentiel créatif de ces bandes offre une expérience d'éclairage sur mesure pour chaque exigence.



# NEON STRIP

collection

**Augenti**<sup>®</sup>  
3/Neon Strip

# CASAMBI

## READY TO CONNECT

**Casambi** è una tecnologia **smart lighting** che sfrutta la rete wireless **Bluetooth** Low Energy (BLE) per gestire e regolare le luci in modo intelligente. Grazie alla sua natura “**ready to connect**”, Casambi può essere facilmente integrato in qualsiasi ambiente senza la necessità di complesse configurazioni. Questa soluzione consente agli utenti di controllare facilmente e in modo personalizzato l’illuminazione tramite smartphone o tablet. Grazie alla sua **flessibilità**, Casambi si distingue come una soluzione versatile ed efficiente per l’illuminazione domestica e professionale.

**Casambi** is a **smart lighting** technology that uses **Bluetooth** Low Energy (BLE) wireless network to intelligently manage and control lights. Due to its “**ready to connect**” nature, Casambi can be easily integrated into any environment without the need for complex configurations. This solution allows users to easily and individually control lighting via smartphone or tablet. Thanks to its **flexibility**, Casambi stands out as a versatile and efficient solution for home and professional lighting.

**Casambi** est une technologie d’**éclairage intelligent** qui utilise le réseau sans fil **Bluetooth** Low Energy (BLE) pour gérer et régler intelligemment l’éclairage. Grâce à sa nature “**prêt à connecter**”, Casambi peut être facilement intégré dans n’importe quel environnement sans avoir besoin de configurations complexes. Cette solution permet aux utilisateurs de contrôler facilement et de manière personnalisée l’éclairage à l’aide d’un smartphone ou d’une tablette. Grâce à sa **flexibilité**, Casambi se distingue comme une solution polyvalente et efficace pour l’éclairage domestique et professionnel.



### Comunicazione Wireless Bluetooth

Wireless Bluetooth Communication  
Communication Sans Fil Bluetooth



### Costo ridotto

Reduced cost  
Coût réduit



### Installazione Semplice

Easy Installation  
Installation Simple



### Interfaccia Utente Intuitiva

User-Friendly Interface  
Interface Intuitive



### Programmabile

Programmable  
Programmable



### Espandibile

Expandable  
Extensible

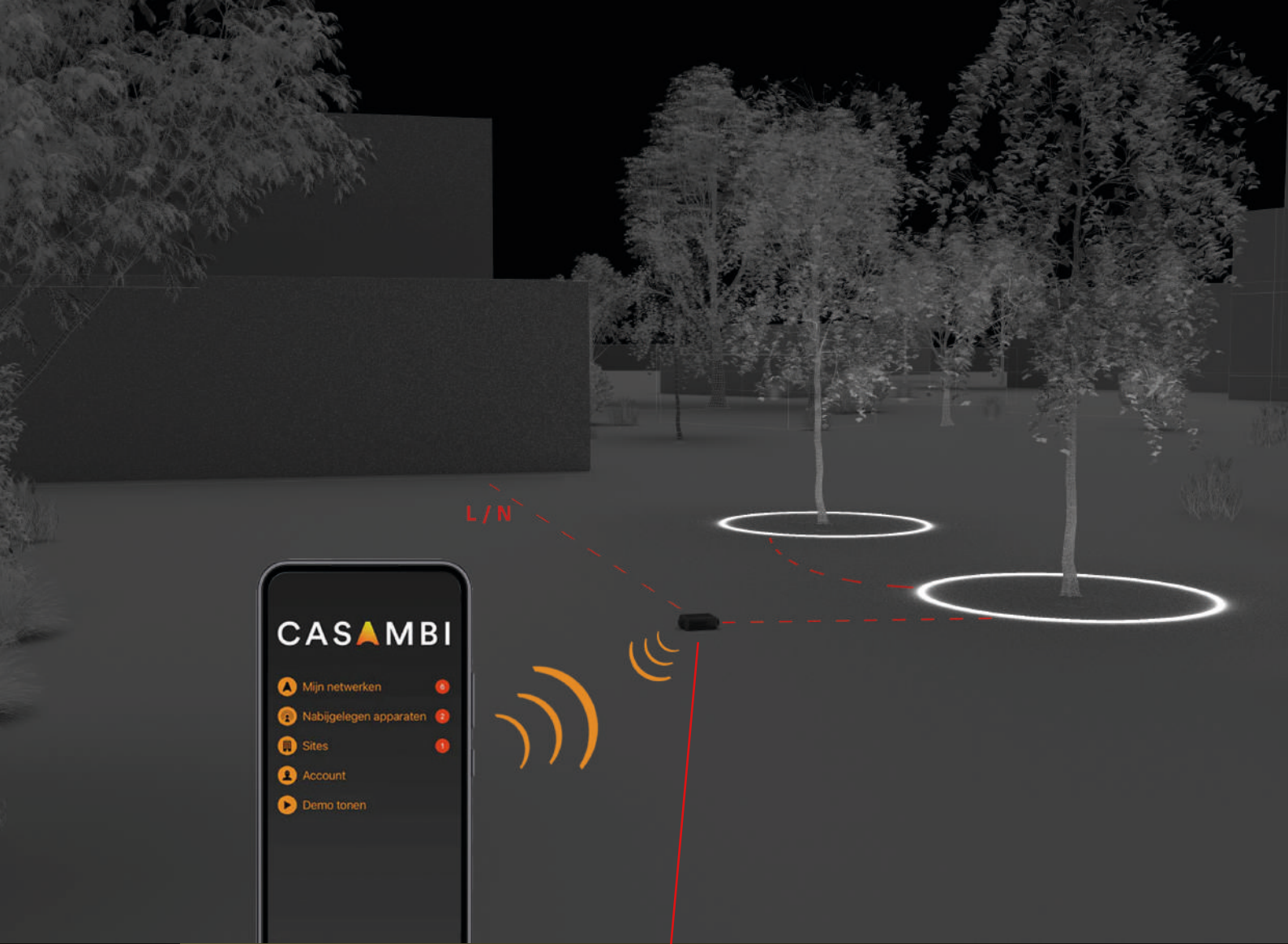

**Augenti<sup>®</sup>**  
**REMOTE**  
CASAMBI

SEMPPLICITY

CONNECTIVITY

FLEXIBILITY

EXPANDABILITY

SUSTAINABLE

**PROGRAMMABLE**

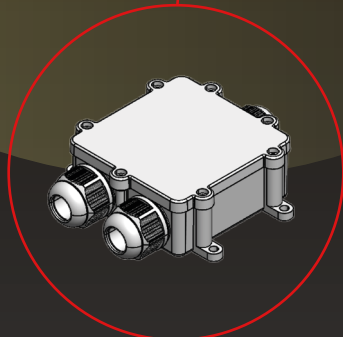

SMART LIGHTING

ECONOMIC ADVANTAGE

WIRELESS

**ADAPTABLE**

BLUETOOTH

# Fixture Specifications

Protection . IP 67 - IK 07

Body . Silicone estrusion

Screen . Silicone



Finishes  
Grey rubber

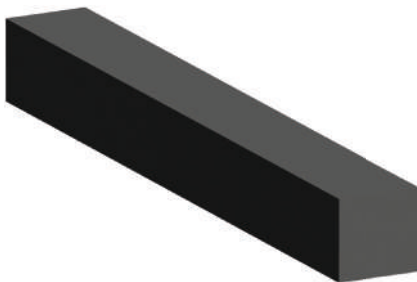

## Technical Data

**NB** FASCIO STRETTO 15° - NARROW BEAM 15°

**MB** FASCIO MEDIO 30° - MEDIUM BEAM 30°

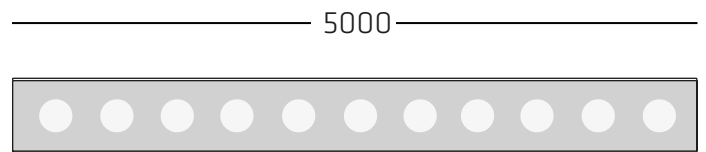
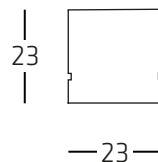

3000K

**Versione in Tensione - Constant voltage (Vdc)**

18W/m con DRIVER REMOTO 24Vdc - 18W/m REMOTE DRIVER 24Vdc

Quote espresse in millimetri "mm"

Share expressed in millimeters "mm"

Sizes . L5000 x H23 x W23

## Specifications







# STRIP LENS

led WHITE

Versione in Tensione - Constant voltage (Vdc)

LED SYSTEM WITH REMOTE DRIVER 24V

code	beam	class	power	W	fixture	CCT LED	CRI
<b>AG115</b> N30K500015	 NB Spot/15°	III	24Vdc	18W/m	1600 lm/m	3000K	80
<b>AG115</b> N30K500030	 MB Wide/30°	III	24Vdc	18W/m	1600 lm/m	3000K	80

## Characteristics

### 3D Dual Bend

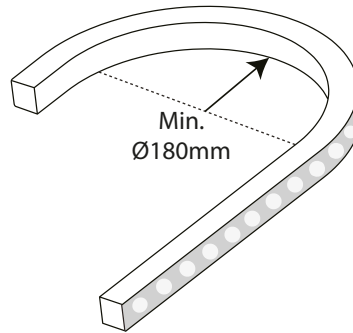
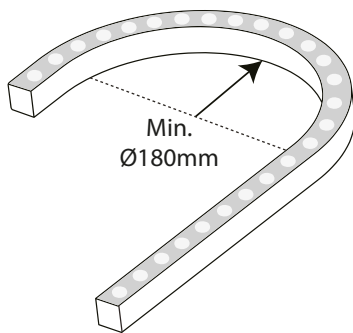

## Accessories

informazioni sugli accessori sul nostro sito web  
information about accessories on our website

DRIVER 24Vdc

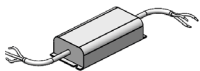

DIMMER  
CASAMBI



END CAPS

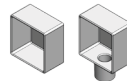

TRANSPARENT  
PLASTIC CLIP

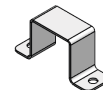

BRACKET



ROTATABLE  
BRACKET

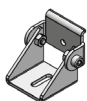

ALUMINIUM  
PROFILE

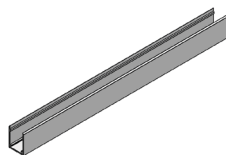

FOLDING  
PROFILE

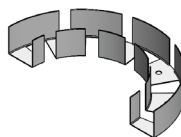

website-link

# NEON STRIP

collection





# Fixture Specifications

Protection . IP 67 - IK 07

Body . Silicone estrusion

Screen . Silicone



## Finishes

White rubber

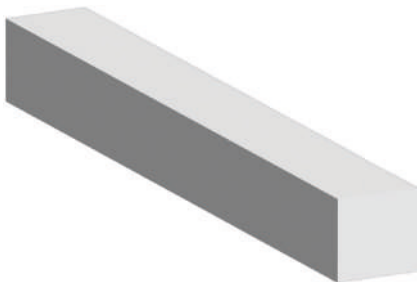

## Technical Data

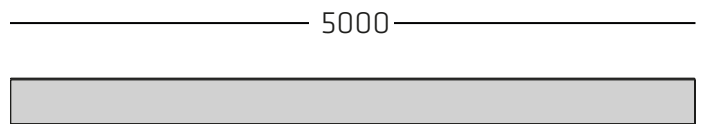

LUCE DIFFUSA - DIFFUSE LIGHT

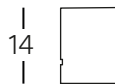

-10-

2700K - 3000K - 4000K

### Versione in Tensione - Constant voltage (Vdc)

14W/m con DRIVER REMOTO 24Vdc - 14W/m REMOTE DRIVER 24Vdc

Quote espresse in millimetri "mm"

Share expressed in millimeters "mm"

Sizes . L5000 x H14 x W10

## Specifications





# STRIP WHITE

led WHITE

Versione in Tensione - Constant voltage (Vdc)

LED SYSTEM WITH REMOTE DRIVER 24V

code	beam	class	power	W	fixture	CCT LED	CRI
<b>AG205</b> 27K5000	 DIFFUSE	III	24Vdc	14W/m	550 lm/m	2700K	80
<b>AG205</b> 30K5000	 DIFFUSE	III	24Vdc	14W/m	550 lm/m	3000K	80
<b>AG205</b> 40K5000	 DIFFUSE	III	24Vdc	14W/m	550 lm/m	4000K	80

## Characteristics

### Side Bending

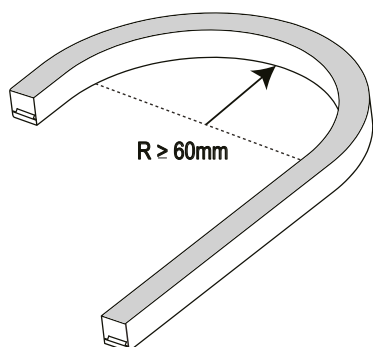

## Accessories

informazioni sugli accessori sul nostro sito web  
information about accessories on our website

DRIVER 24Vdc

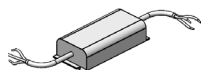

DIMMER  
CASAMBI



END CAPS

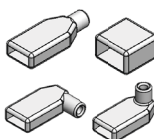

TRANSPARENT  
PLASTIC CLIP

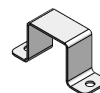

BRACKET



ALUMINIUM  
PROFILE

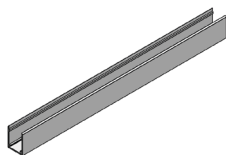

FOLDING  
PROFILE

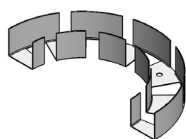

website-link

# Fixture Specifications

Protection . IP 67 - IK 07

Body . Silicone estrusion

Screen . Silicone



## Finishes

White rubber

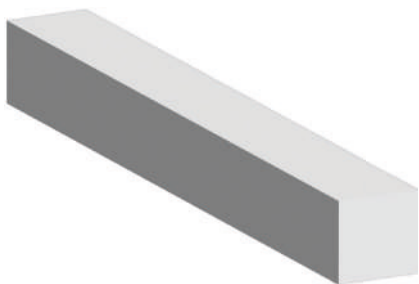

## Technical Data

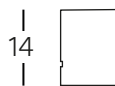
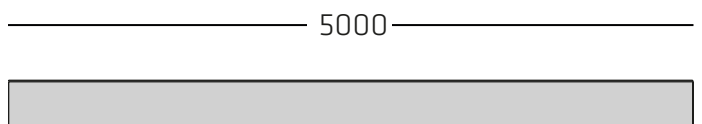

-10-

LUCE DIFFUSA - DIFFUSE LIGHT

### Versione in Tensione - Constant voltage (Vdc)

14W/m con DRIVER REMOTO 24Vdc - 14W/m REMOTE DRIVER 24Vdc

Quote espresse in millimetri "mm"

Share expressed in millimeters "mm"

Sizes . L5000 x H14 x W10

## Specifications



# STRIP **RGBW**

Versione in Tensione - Constant voltage (Vdc)

**LED SYSTEM WITH REMOTE DRIVER 24V**

code	beam	class	power	W	fixture	CCT LED	CRI
<b>AG205</b> RGBW5000	 DIFFUSE	III	24Vdc	14W/m	240 lm/m	RGBW 3000K	80

## Characteristics

### Side Bending

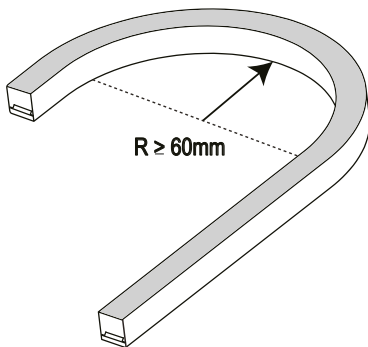

## Accessories

informazioni sugli accessori sul nostro sito web  
information about accessories on our website

DRIVER 24Vdc

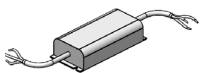

RGBW  
CONTROL UNIT

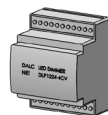

TOUCH  
CONTROLLER



SPLITTER



END CAPS

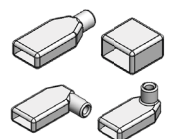

TRANSPARENT  
PLASTIC CLIP

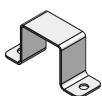

BRACKET



ALUMINIUM  
PROFILE

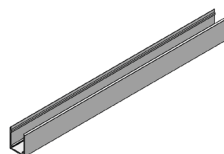

FOLDING  
PROFILE

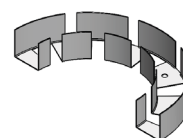

website-link

# NEON STRIP

collection

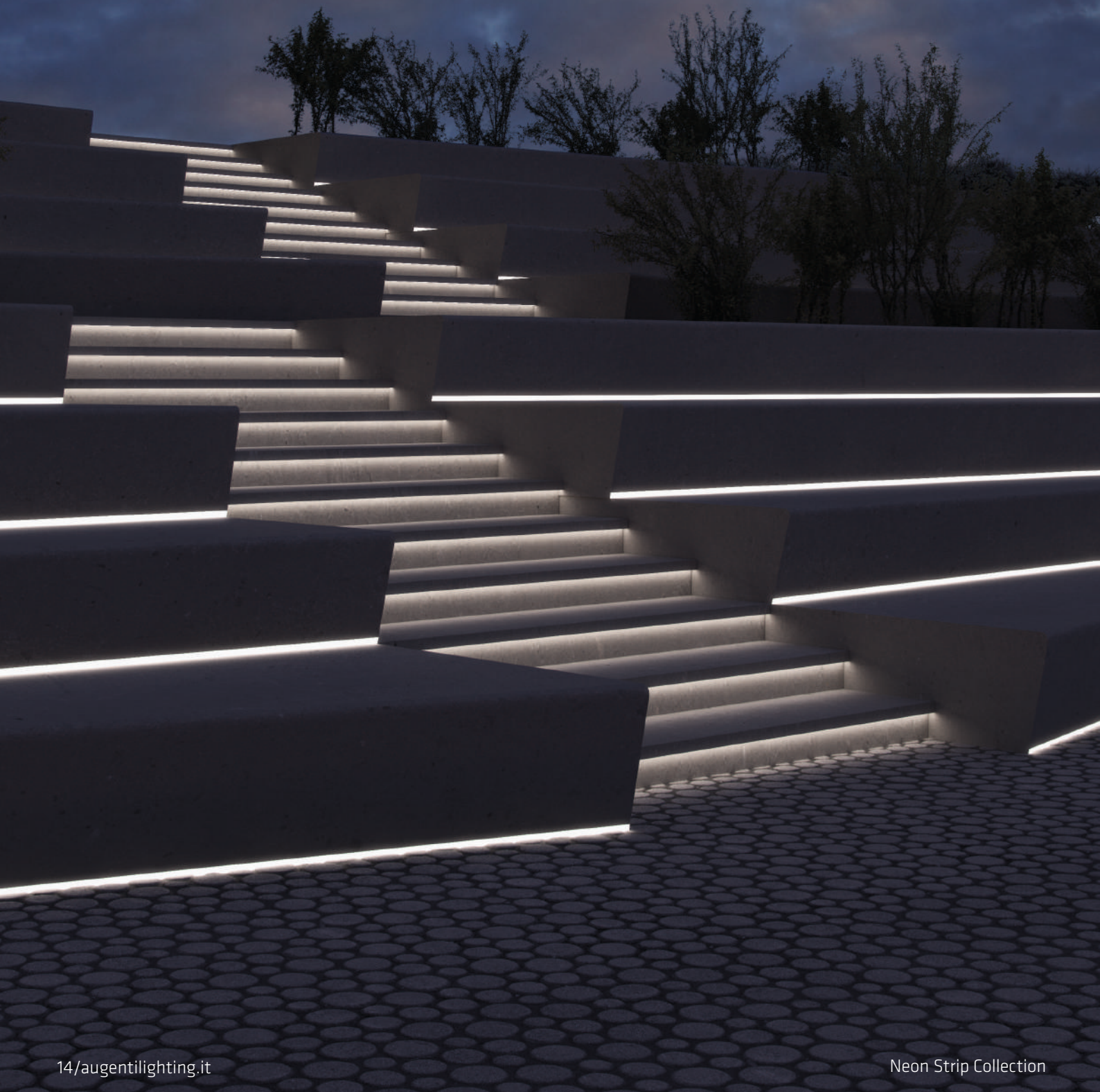





**NEON STRIP**

GOOD

INSTALLATION

BY **Augenti**<sup>®</sup>  
LIGHTING





# Augenti<sup>®</sup>

LIGHTING



**AUGENTI LIGHTING S.R.L.** UNIPERSONALE

Via Francesco Lana, 31 - 25065 Lumezzane (BS) Italy - tel: (+39) 030 7282524 - fax: (+39) 030 7281879  
info@augentilighting.it - www.augentilighting.it